

## COOL POWER TECHNOLOGIES

### Thirty-Second-Brick Isolated DC/DC Converter

#### Features

- Tiny DOSA standard 32<sup>nd</sup> brick footprint
- Wide input voltage range: 36 – 75Vin
- Output: 5 V at 5 A, 25W max.
- No minimum load/capacitance required
- On-board input differential “PI” LC-filter
- Low height - 0.35” (8.9mm) max.
- Basic Insulation w/1500VDC I/O isolation
- Withstands 100 V input transients
- Fixed-frequency operation
- Full protection (OTP, OCP, OVP, UVLO – auto-restart)
- Remote ON/OFF - positive or negative enable logic options
- Remote sense
- Output voltage trim range: +10%/–20% (industry-standard trim equations)
- Weight: 0.2 oz [5.67 g]
- Meets UL94, V-0 flammability rating
- UL/CSA60950-1 recognized, TUV certified per IEC/EN60950-1, 2<sup>nd</sup> edition (pending)
- Designed to meet Class B conducted emissions per FCC and EN55022 when used with external filter (see EMC Compliance section for recommended filter.)

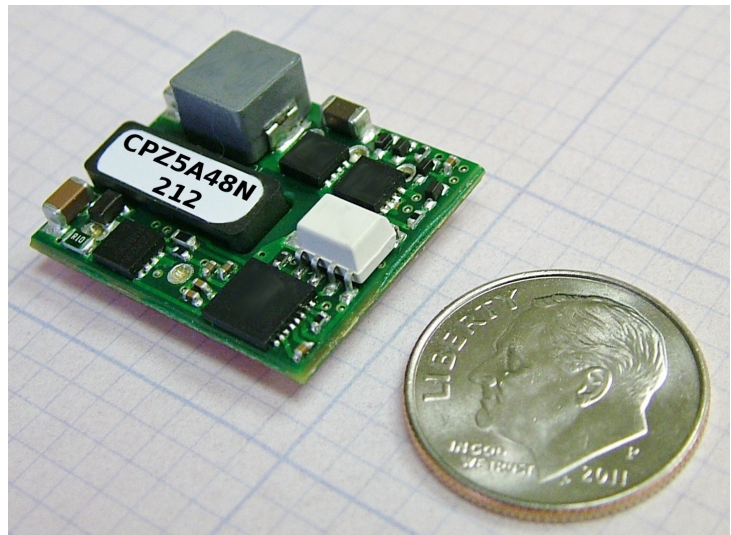

#### Description

The “Cool Power Technologies” CPZ5A48 DC-DC converter is an open frame isolated 32<sup>nd</sup> brick DC-DC module that conforms to DOSA standard 32<sup>nd</sup> brick specifications. The converter operates over an input voltage range of 36 to 75 VDC, and provides a tightly regulated output voltage with an output current rating of 5 A. The output is fully isolated from the input and the converter meets Basic Insulation requirements with 1500VDC I/O isolation rating. The standard feature set includes remote On/Off (positive or negative enable), input undervoltage lockout, output overvoltage protection, overcurrent and short circuit protections, output voltage trim, remote sense and overtemperature shutdown with hysteresis. The high efficiency of the CPZ5A48 allows operation over a wide ambient temperature range with minimal derating (full rated power @ 75°C & 200LFM (1m/s) airflow @ 36 - 60Vin.)



ELECTRICAL SPECIFICATIONS

36–75Vin, 5V/5Aout

Conditions:  $T_A = 25\text{ }^\circ\text{C}$ , Airflow = 300 LFM,  $V_{in} = 48\text{ VDC}$ ,  $C_{in} = 33\text{ }\mu\text{F}$ , unless otherwise specified.

Input Characteristics					
Parameter	Conditions	Min	Typ	Max	Unit
Operating Input Voltage Range		36	48	75	VDC
Input Under-Voltage Lock-out Turn-on Threshold Turn-off Threshold		34.2	35.0	35.9	VDC
		32.4	33.2	34.1	
Input Voltage Transient	100ms max.			100	VDC
Maximum Input Current	$V_{IN} = 36\text{VDC}; I_{out} = 5\text{A}$			0.81	A
Input Standby Current	Converter Disabled		2	5	mA
Input No-Load Current	Converter Enabled		36	50	mA
Short Circuit Input Current			10	20	$\text{mA}_{\text{RMS}}$
Input Reflected Ripple Current	5Hz to 50MHz See Fig 1 for setup		5	10	$\text{mA}_{\text{PK-PK}}$
Input Voltage Ripple Rejection	120Hz		50		dB
Inrush Current	All	-	0.0005	0.05	$\text{A}^2\text{-S}$
Output Characteristics					
Parameter	Conditions	Min	Typ	Max	Unit
Output Voltage Set point	Sense pins connected to output pins	4.925	5.00	5.075	VDC
Output Current		0		5	A
Output Current Limit Inception		5.5	6.5	8	A
Peak Short-Circuit Current	10m $\Omega$ Short		11.5	14	A
RMS Short-Circuit Current	10m $\Omega$ Short		0.8	1.3	$\text{A}_{\text{RMS}}$
External Load Capacitance				4700	$\mu\text{F}$
Output Ripple and Noise 20 MHz bandwidth	1 $\mu\text{F}$ Ceramic + 400 $\mu\text{F}$ (4x100) Ceramic See Fig 2 for setup		15	30	$\text{mV}_{\text{PK-PK}}$
	1 $\mu\text{F}$ Ceramic + 10 $\mu\text{F}$ Tantalum See Fig 3 for setup		35	60	$\text{mV}_{\text{PK-PK}}$
Output Regulation Line: Load: Overall Output Regulation:	Over line, load & temp.	4.85	$\pm 0.02$	$\pm 0.1$	$\%V_o$
			$\pm 0.02$	$\pm 0.1$	$\%V_o$
				5.15	V

ELECTRICAL SPECIFICATIONS (continued)

36–75V<sub>in</sub>, 5V/5A<sub>out</sub>

Conditions: T<sub>A</sub> = 25 °C, Airflow = 300 LFM, V<sub>in</sub> = 48 VDC, C<sub>in</sub> = 33 μF, unless otherwise specified.

Efficiency					
Parameter	Conditions	Min	Typ	Max	Unit
100% Load		87	88		%
50% Load		83	85.5		%
Dynamic Response					
Parameter	Conditions	Min	Typ	Max	Unit
Load Change 25%-50% or 50%-75% of I <sub>out</sub> Max, di/dt = 0.1 A/μs	C <sub>out</sub> = 1 μF ceramic + 10 μF tantalum See Fig 3		60	120	mV
Settling Time to 1% of V <sub>out</sub>			50		μs
Load Change 25%-50% or 50%-75% of I <sub>out</sub> Max, di/dt = 2.0 A/μs	C <sub>out</sub> = 1 μF ceramic + 400 μF ceramic See Fig 2		100	150	mV
Settling Time to 1% of V <sub>out</sub>			50		μs
Isolation Specifications					
Isolation Capacitance			1000		pF
Isolation Resistance		10			MΩ
Isolation Voltage – Input to Output				1500	V <sub>DC</sub>

ELECTRICAL SPECIFICATIONS (continued)

36–75Vin, 5V/5Aout

Conditions: Ta = 25 °C, Airflow = 300 LFM, Vin = 48 VDC, Cin=33 µF, unless otherwise specified.

Absolute Maximum Ratings					
Parameter	Conditions	Min	Typ	Max	Unit
Input Voltage	Continuous Operation	0		75	VDC
Operating Ambient Temperature		-40		85	°C
Storage Temperature		-55		125	°C
Feature Characteristics					
Parameter	Conditions	Min	Typ	Max	Unit
Switching Frequency			480		kHz
Output Voltage Trim Range		-20		+10	%
Remote Sense Compensation				+10	%
Output Over-voltage Protection	Non-latching	120	130	140	%
Over-temperature Protection	Avg. PCB temp, non-latching		125		°C
Peak Backdrive Output Current (during startup into prebiased output)	Sinking current from external voltage source equal to V <sub>OUT</sub> – 0.6V and connected to the output via 1Ω resistor. C <sub>OUT</sub> =220µF, Aluminum		350	500	mA
Backdrive Output Current in OFF state	Converter disabled		0	5	mA
Power On to Output Turn-ON Time	V <sub>OUT</sub> = 0.9*V <sub>OUT_NOM</sub>		15	40	mS
Enable to Output Turn-ON Time	V <sub>OUT</sub> = 0.9*V <sub>OUT_NOM</sub>		15	40	mS
Output Enable ON/OFF					
Negative Enable					
Converter ON		-0.5		0.8	VDC
Converter OFF		2.4		20	VDC
Positive Enable					
Converter ON		2.4		20	VDC
Converter OFF		-0.5		0.8	VDC
Enable Pin Current Source/Sink			0.25	1	mA
Output Voltage Overshoot @ Startup			0	2	%Vo
Auto-Restart Period	(OVP, OCP)		100		mS



**INPUT REFLECTED RIPPLE TEST SETUP:**

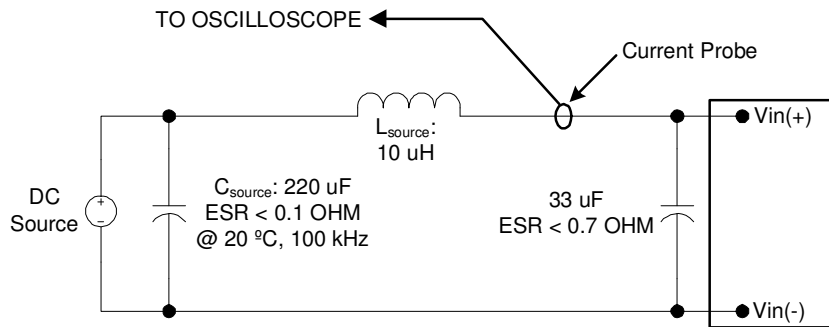

**Note:** Measure input reflected-ripple current with a simulated source inductance ( $L_{test}$ ) of 10  $\mu$ H. Capacitor  $C_s$  offsets possible source impedance.

Figure 1. Input Reflected-ripple Current Test Setup.

**OUTPUT RIPPLE TEST SETUP:**

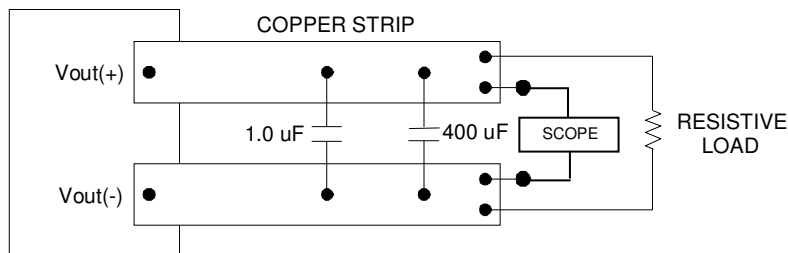

Use a 1.0 $\mu$ F X7R ceramic capacitor and 400 $\mu$ F (4x100 $\mu$ F) ceramic capacitor. Scope measurement made using a BNC socket. Position the load 3 in. [76mm] from module.

Figure 2. Peak-to-Peak Output Noise Measurement Test Setup.

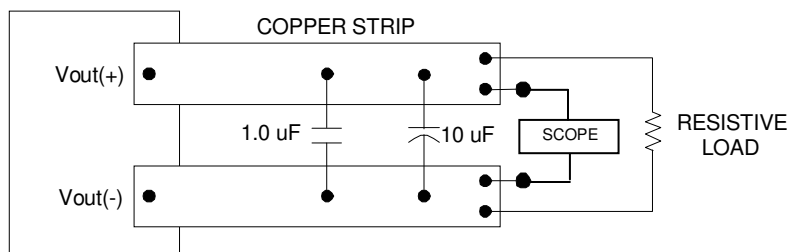

Figure 3. Peak-to-Peak Output Noise Measurement Test Setup (alternate.)

Use a 1.0 $\mu$ F X7R ceramic capacitor and 10 $\mu$ F @20V low ESR tantalum capacitor. Scope measurement made using a BNC socket. Position the load 3 in. [76mm] from module.

CHARACTERISTIC CURVES:

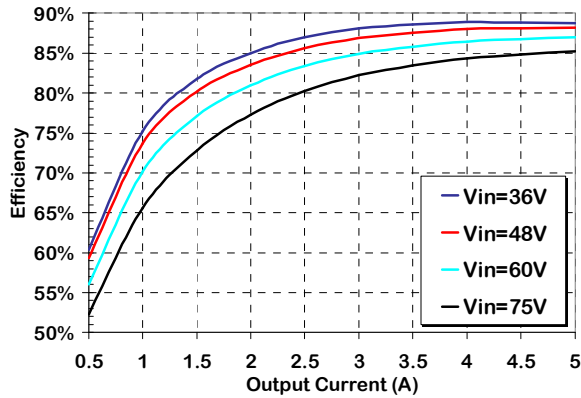

Figure 3. Efficiency vs Output Current, 300lfm airflow, 25°C ambient.

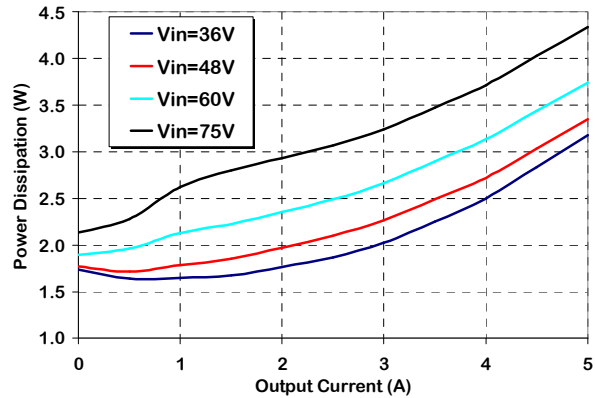

Figure 4. Power Dissipation vs. Load Current, 300lfm airflow, 25°C ambient.

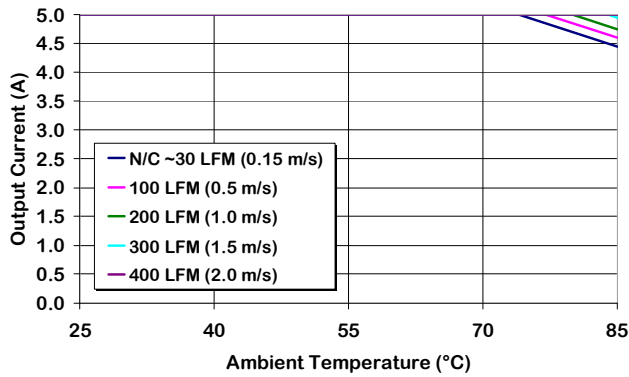

Figure 5. Output Current Derating vs Ambient Temperature & Airflow (converter mounted vertically with air flowing from pin 3 to pin 1, Vin = 36-48 V.)

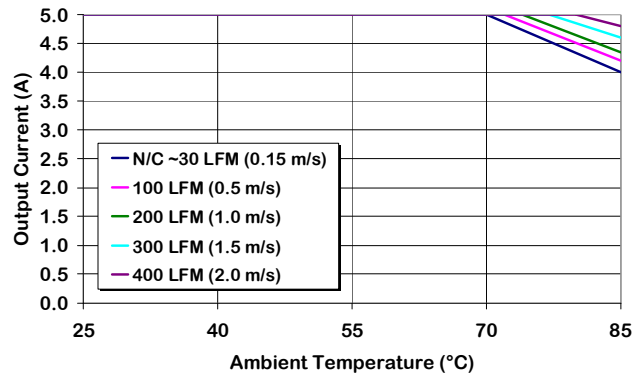

Figure 6. Output Current Derating vs Ambient Temperature & Airflow (converter mounted vertically with air flowing from pin 3 to pin 1, Vin = 60 V.)

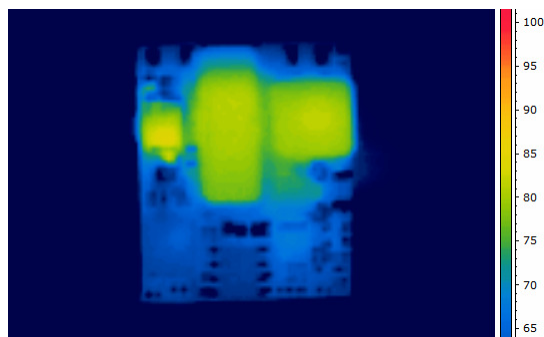

Figure 7. Thermal Image of CPZ5A48 (5A output, 25C Ambient, no airflow, Vin = 48V, T<sub>max</sub> = 85°C)

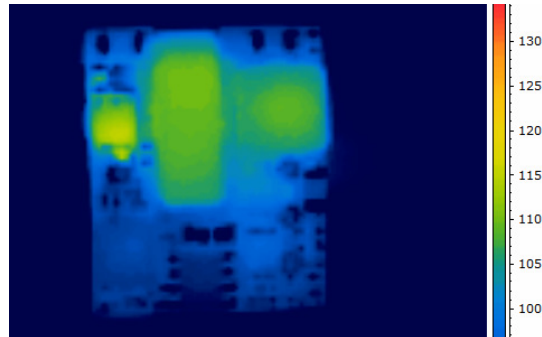

Figure 8. Thermal Image of CPZ5A48 (5A output, 70C Ambient, 200lfm airflow, Vin = 48V, T<sub>max</sub> = 115°C)

CHARACTERISTIC WAVEFORMS:

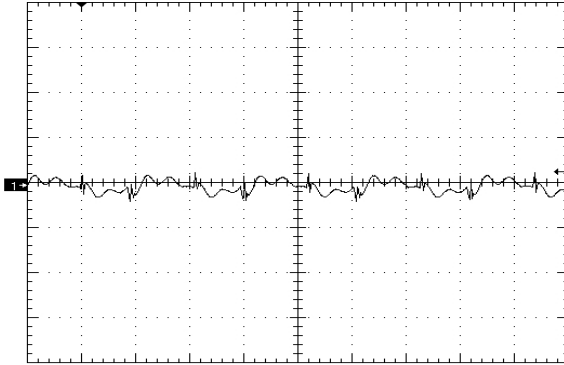

Figure 9. Output Voltage Ripple (20mV/div), time scale – 1uS/div. Vin=Vin\_nom, full load Cout=1uF ceramic + 4x 100uF Ceramic (see Fig 2)

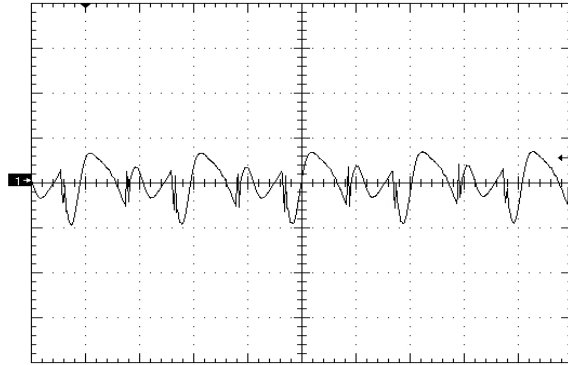

Figure 10. . Output Voltage Ripple (20mV/div), time scale – 1uS/div. Vin=Vin\_nom, full load Cout=1uF ceramic + 10uF Tantalum (see Fig 3)

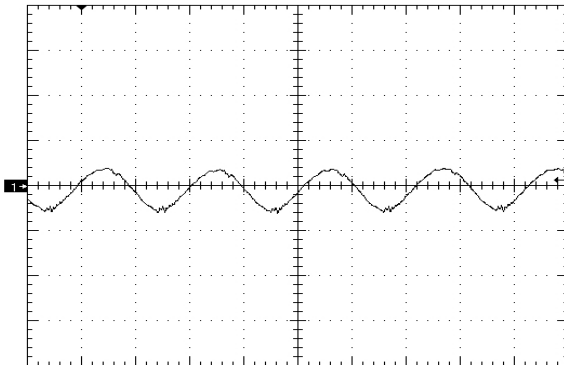

Figure 11. Input Reflected Ripple Current (5mA/div) time scale - 1uS/div. Vin=Vin\_nom, full resistive load (see Fig 1)

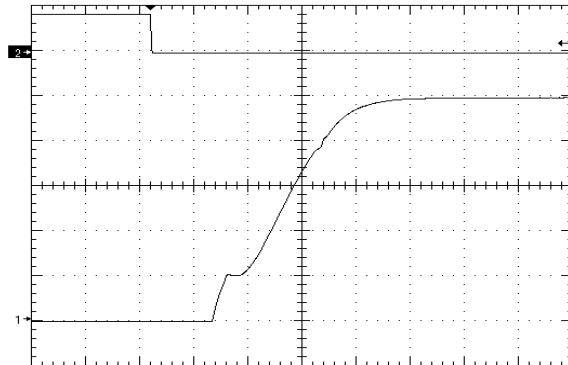

Figure 12. Startup Waveform via Enable Pin, time scale 4mS/div. Vin=Vin\_nom, iout=no load Cout=400uF, Ch1=Vout (1V/div), Ch2=enable (5V/div)

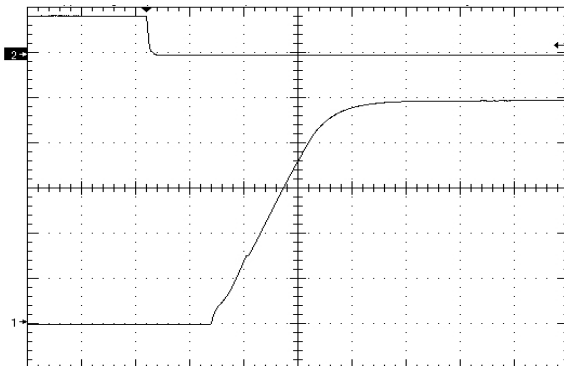

Figure 13. Startup Waveform via Enable Pin, time scale 4mS/div. Vin=Vin\_nom, full res. load + Cout=400uF, Ch1=Vout (1V/div), Ch2=enable (5V/div)

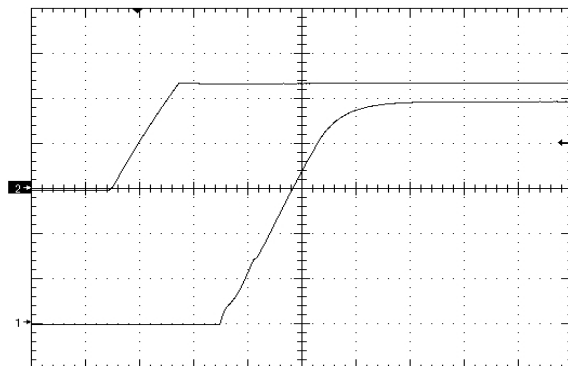

Figure 14. Startup Waveform via Input Voltage, time scale 4mS/div. Vin=Vin\_nom, full res. load + Cout=400uF, Ch1=Vout (1V/div), Ch2=Vin (20V/div)

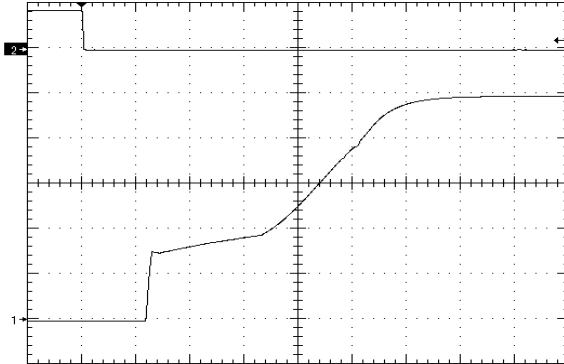

Figure 15. Startup Waveform via Enable Pin, time scale 4mS/div.  $V_{in}=V_{in\_nom}$ ,  $I_{out}$ =no load  $C_{out}=0$ , Ch1=Vout (1V/div), Ch2=enable (5V/div)

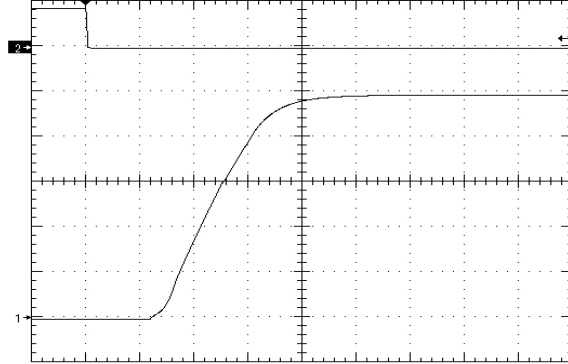

Figure 16. Startup Waveform via Enable Pin, time scale 4mS/div.  $V_{in}=V_{in\_nom}$ , full res. load + 4700uF, Ch1=Vout (1V/div), Ch2=enable (5V/div)

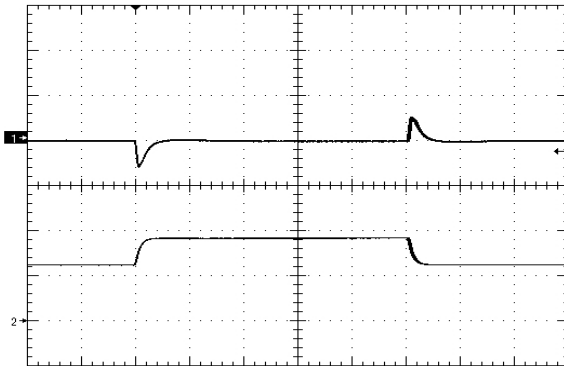

Figure 17. Load Transient Response (100mV/div),  $di/dt=0.1A/uS$ , 50% - 75% - 50% of full load,  $C_{out}$ =Fig3 time scale: 200uS/div. Ch1=Vout, Ch2=Iout (2A/div)

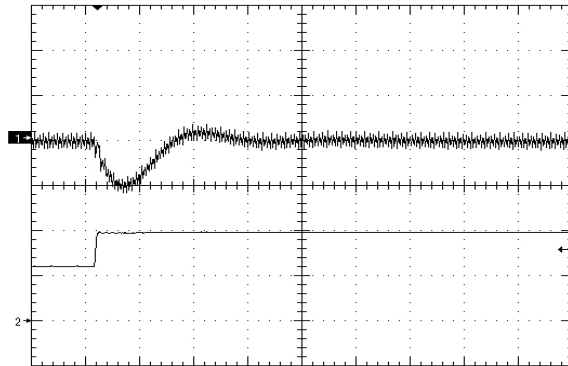

Figure 18. Load Transient Response (100mV/div),  $di/dt=2A/uS$ , 50% - 75% of full load + 400uF Ceramic time scale: 40uS/div. Ch1=Vout, Ch2=Iout (2A/div)

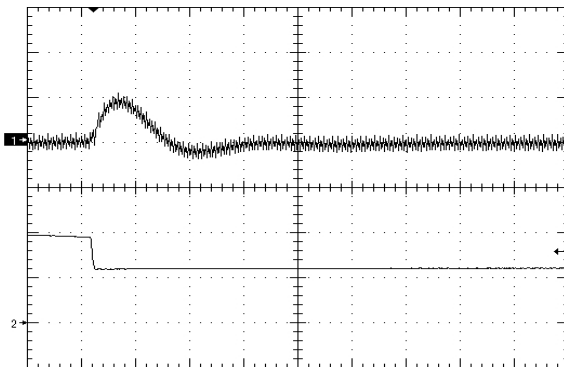

Figure 19. Load Transient Response (100mV/div),  $di/dt=2A/uS$ , 75% - 50% of full load + 400uF Ceramic time scale: 40uS/div. Ch1=Vout, Ch2=Iout (2A/div)

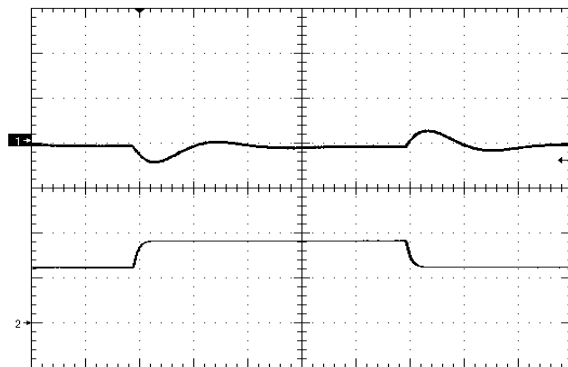

Figure 20. Load Transient Response (50mV/div),  $di/dt=0.1A/uS$ , 50% - 75% - 50% of full load + 2000uF low ESR Oscon, time scale: 200uS/div. Ch1=Vout, Ch2=Iout (2A/div)



### OUTPUT VOLTAGE TRIM

Output voltage adjustment is accomplished by connecting an external resistor between the Trim Pin and either the +Vout (or +Sense) or -Vout (or -Sense) Pins.

#### TRIM UP EQUATION:

$$R_{trim\_up} = \left[ \frac{5.1 \times V_{o\_nom} \times (100 + \Delta\%)}{1.225 \times \Delta\%} - \frac{510}{\Delta\%} - 10.2 \right] \times k\Omega$$

Where  $R_{trim\_up}$  is the resistance value in k-ohms and  $\Delta\%$  is the percent change in the output voltage.

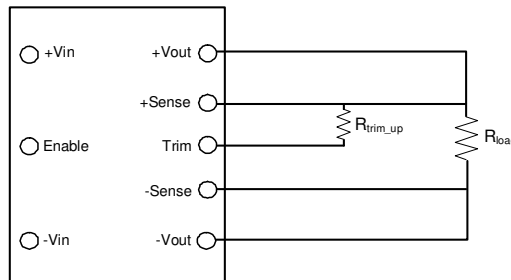

Figure 21. Trim UP circuit configuration

#### TRIM-DOWN EQUATION:

$$R_{trim\_down} = \left( \frac{510}{\Delta\%} - 10.2 \right) \times k\Omega$$

Where  $R_{trim\_down}$  is the resistance value in k ohms and  $\Delta\%$  is the percent change in the output voltage.

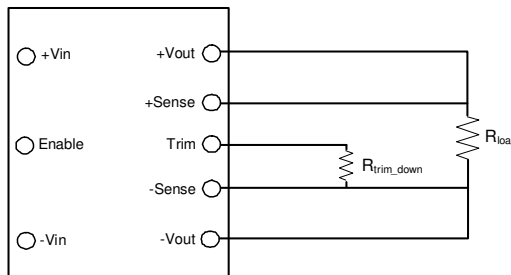

Figure 22. Trim DOWN circuit configuration

**EMC COMPLIANCE:**

To meet Class B compliance for EN55022 (CISPR 22) or FCC part 15 sub part j, the following input filter is required:

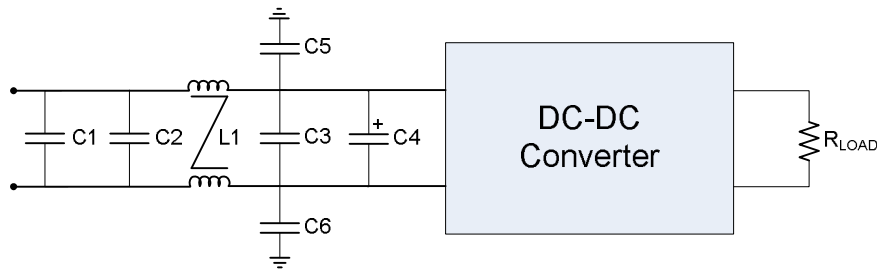

Figure 23. EMI Filter

L1 =	590 uH Common Mode Inductor (Pulse P0353NL)
C1,C2,C3 =	2.2uF ceramic
C4 =	100uF electrolytic
C5,C6 =	10nF (@2kV if output is ref. to gnd.)

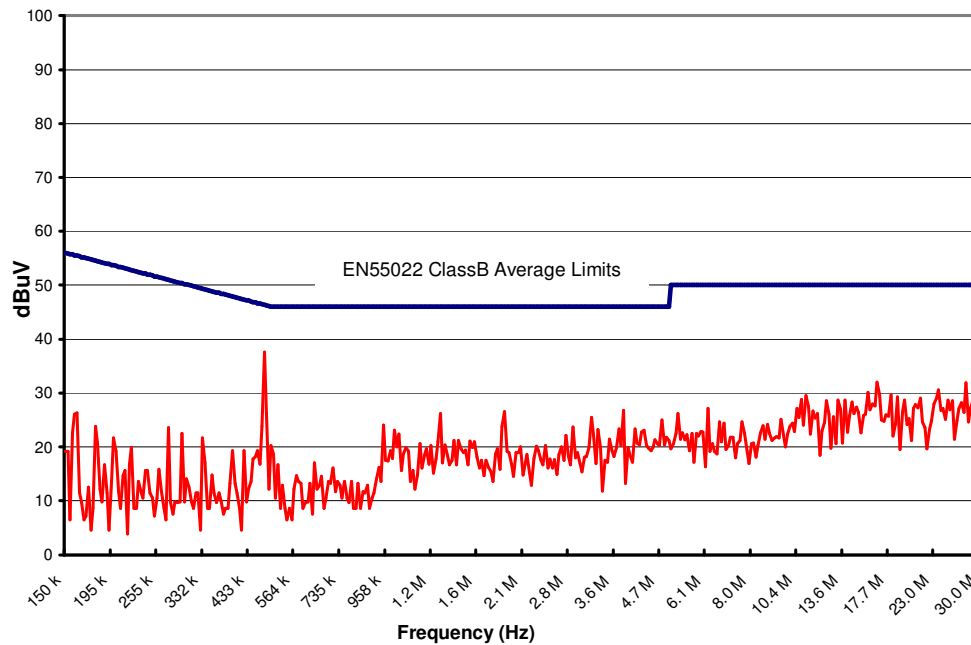
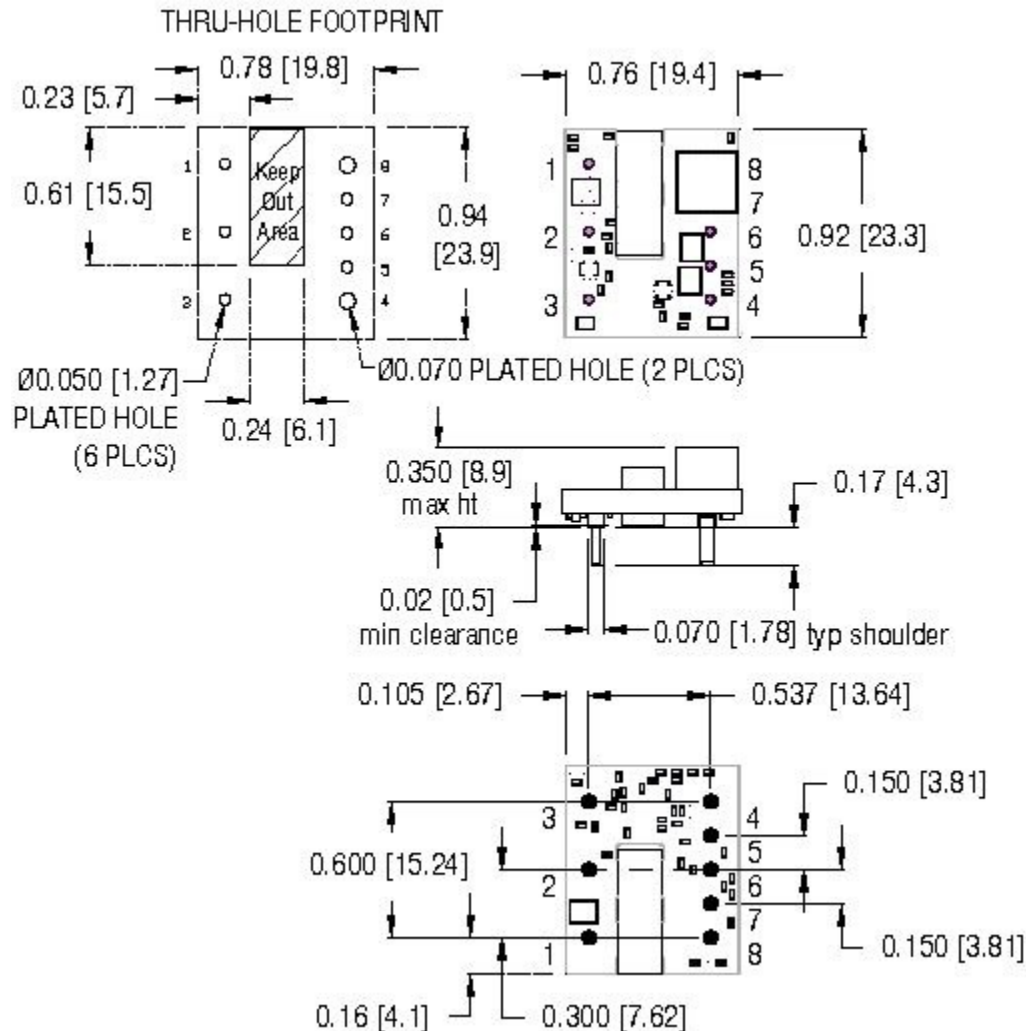

Figure 24. CPZ5A48 Conducted Emissions using above specified input filter.  
 Vin = 48V, Full Resistive Load

## MODULE PIN ASSIGNMENT & MECHANICAL OUTLINE

PIN #	DESIGNATION	NOTES
1	V <sub>IN</sub> (+)	1) All dimensions in inches [mm] Tolerances: .xx ± 0.02 [.x ± .5] .xxx ± 0.010 [.xx ± .25]
2	On/Off	
3	V <sub>IN</sub> (-)	2) TH pins 1-3 & 5-7 are Ø 0.040" [1.02] with Ø 0.070" [1.77] standoff shoulders.
4	V <sub>OUT</sub> (-)	3) TH output pins 4 & 8 are Ø 0.062" [1.57] with 0.090" [2.29] standoff shoulder.
5	Sense (-)	4) SMT pins are 0.040" lead-free solder ball pins.
6	Trim	5) Keep Out Area – no copper traces or vias should be placed in this area.
7	Sense (+)	6) All pins are tin plated with nickel under plating (ROHS).
8	V <sub>OUT</sub> (+)	7) Weight: 5.67 g (0.2 oz.)
		8) Workmanship: Meets or exceeds IPC-A-610 Class II

## MECHANICAL OUTLINE – THROUGH HOLE



MECHANICAL OUTLINE – SURFACE MOUNT

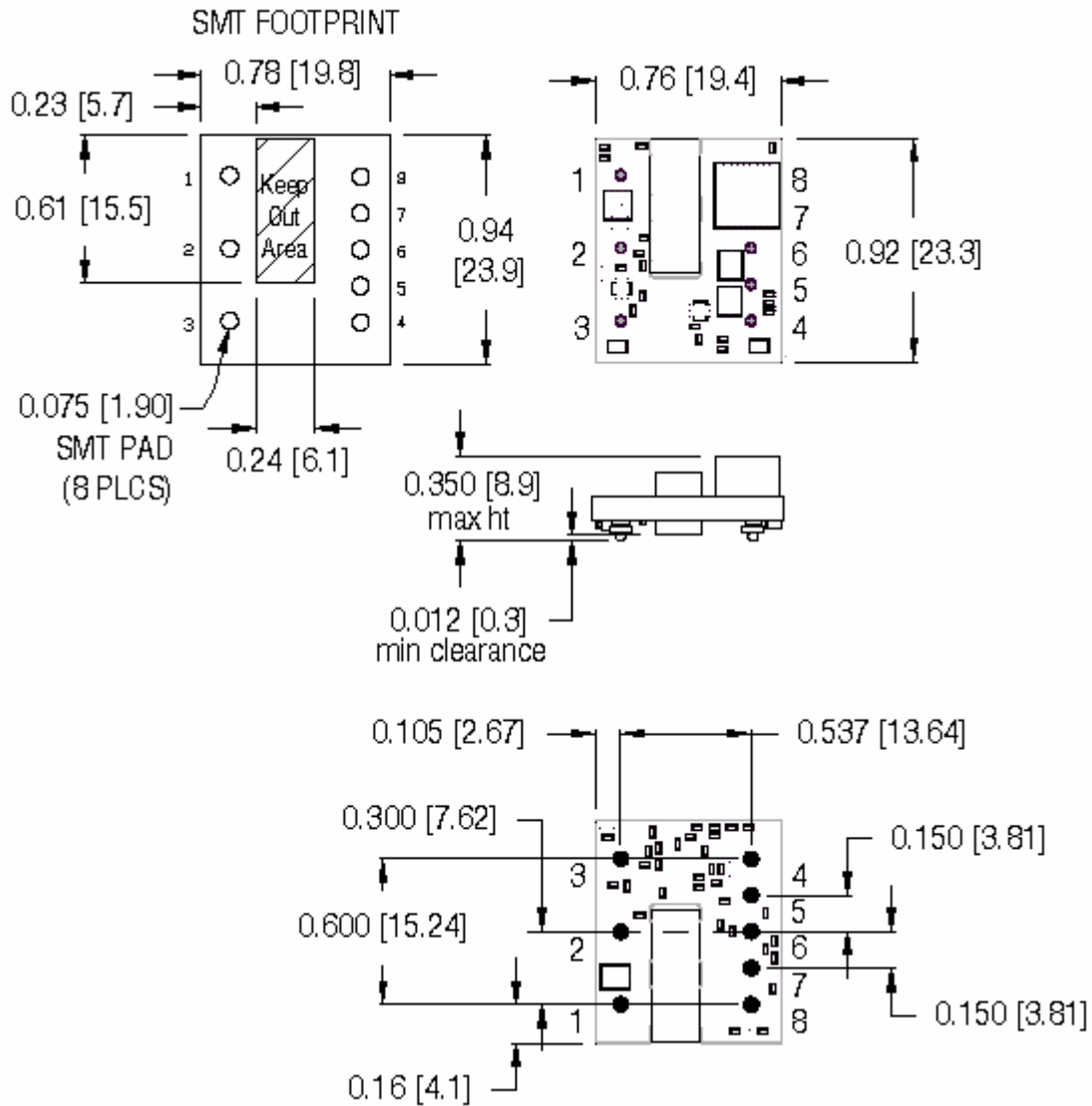



**Ordering Information:**

Product Identifier	Output Current	Output Voltage	Input Voltage	Enable logic option	Additional features
CPZ	5	A	48	N or P	- XX
“Cool Power” 32 <sup>nd</sup> Brick	5A	5V	36 – 75V	N = Negative P = Positive	TBD

Rev 1.1, 13-Feb-13