

## COOL POWER TECHNOLOGIES

### 30W Isolated DC/DC Converter

#### Features

- Ultra-wide input voltage range: 18 – 75Vin
- Output: 12 V at 2.5 A, 30W max.
- Tiny 0.94" X 0.94" x 0.35" max ht (Open Frame)
- 1" x 1" x 0.4" standard encapsulated product
- ROHS II Directive 2011/65/EU Compliant
- No minimum load/capacitance required
- On-board input differential "PI" LC-filter
- Withstands 100 V input transients
- Fixed-frequency operation
- Meets UL94, V-0 flammability rating
- Full protection (OTP, OCP, OVP, UVLO w/auto-restart)
- Remote ON/OFF - positive or negative enable logic options
- Output voltage trim range:  $\pm 10\%$  (see Output Voltage Trim Equations section)
- Weight: 0.266 oz [7.54 g] (open frame), 0.67 oz [19g] (encapsulated)
- Basic Insulation w/2250VDC I/O isolation (open frame), 1600VDC (encapsulated)
- Complies with UL/CSA60950-1, TUV per IEC/EN60950-1, 2<sup>nd</sup> edition
- Compliant to REACH (EC) No 1907/2006
- Designed to meet Class B conducted emissions per FCC and EN55032 when used with external filter (see EMC Compliance section below.)

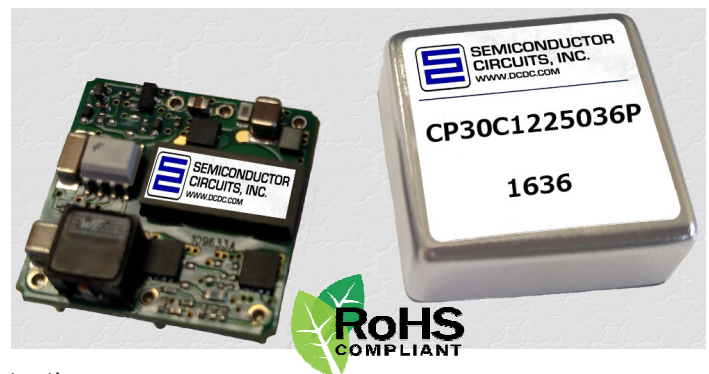

#### Description

The "Cool Power Technologies" CP30\_1225036 DC-DC converter is an open frame isolated 1" X 1" DC-DC module that conforms to industry standard pinout and trim equations. The converter operates over an input voltage range of 18 to 75 VDC, and provides a tightly regulated output voltage with an output current rating of 2.5 A. The output is fully isolated from the input and the converter meets Basic Insulation requirements with 2250VDC I/O isolation rating open frame, 1600VDC for the encapsulated version. The standard feature set includes remote On/Off (positive or negative enable), input undervoltage lockout, output overvoltage protection, overcurrent and short circuit protections, output voltage trim and overtemperature shutdown with hysteresis. The high efficiency of the CP30\_1225036 allows operation over a wide ambient temperature range with minimal derating.

TABLE OF CONTENTS

| SECTION                            | PAGE |
|------------------------------------|------|
| FEATURES & DESCRIPTION             | 1    |
| APPLICATION DIAGRAM                | 2    |
| ELECTRICAL SPECIFICATIONS          | 3    |
| CHARACTERISTIC PERFORMANCE CURVES  | 6    |
| CHARACTERISTIC WAVEFORMS           | 7    |
| APPLICATION NOTES                  | 9    |
| • RIPPLE MEASUREMENTS TEST SET-UP  | 9    |
| • OUTPUT VOLTAGE TRIM EQUATIONS    | 10   |
| • THERMAL DERATING                 | 11   |
| • EMC COMPLIANCE                   | 13   |
| MECHANICAL OUTLINE & PCB FOOTPRINT | 14   |
| ORDERING INFORMATION               | 16   |

APPLICATION DIAGRAM

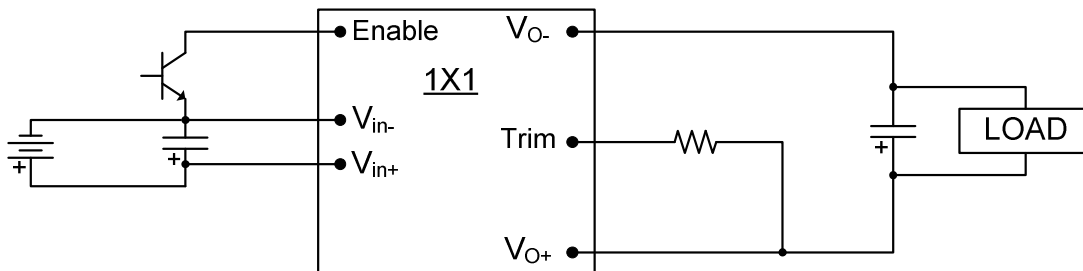

ELECTRICAL SPECIFICATIONS

18–75Vin, 12V/2.5Aout

Conditions: T<sub>A</sub> = 25 °C, Airflow = 300 LFM, Vin = 48 VDC, Cin = 33 µF, unless otherwise specified.

| Input Characteristics   |  |              |                |                       |                     |
|---|--|--------------|----------------|-----------------------|---------------------|
| Parameter   | Conditions   | Min          | Typ            | Max                   | Unit                |
| Operating Input Voltage Range   |  | 18           | 48             | 75                    | VDC                 |
| Input Under-Voltage Lock-out<br>Turn-on Threshold<br>Turn-off Threshold |  | 17.5<br>15.6 | 17.8<br>16.0   | 18.1<br>16.5          | VDC                 |
| Input Voltage Transient   | 100ms  |              |                | 100                   | VDC                 |
| Maximum Input Current   | V <sub>IN</sub> = 18VDC; I <sub>OUT</sub> = 2.5A         |              |                | 2.1                   | A                   |
| Input Standby Current   | Converter Disabled                                       |              | 2              | 5                     | mA                  |
| Input No-Load Current   | Converter Enabled  |              | 40             |                       | mA                  |
| Short Circuit Input Current   | RMS  |              | 10             |                       | mA                  |
| Input Reflected Ripple Current  | 5Hz to 50MHz<br>See Fig 15 for setup                     |              | 20             | 30                    | mA <sub>PK-PK</sub> |
| Input Voltage Ripple Rejection  | 120Hz  |              | 50             |                       | dB                  |
| Inrush Current  | All  | -            |                | 0.1                   | A <sup>2</sup> /s   |
| Output Characteristics  |  |              |                |                       |                     |
| Parameter   | Conditions   | Min          | Typ            | Max                   | Unit                |
| Output Voltage Set point  |  | 11.85        | 12.00          | 12.15                 | VDC                 |
| Output Current  |  | 0            |                | 2.5                   | A                   |
| Output Current Limit Inception  |  | 2.6          | 3.8            | 5.2                   | A                   |
| Peak Short-Circuit Current  | 10mΩ Short   |              |                | 8                     | A                   |
| RMS Short-Circuit Current   | 10mΩ Short   |              | 1.5            | 2.5                   | A <sub>RMS</sub>    |
| External Load Capacitance <sup>1</sup>                                  |  | 0            |                | 470                   | µF                  |
| Output Ripple and Noise<br>20 MHz bandwidth                             | 0.1 µF Ceramic +<br>22µF Ceramic<br>See Fig 16 for setup |              | 30             | 80                    | mV <sub>PK-PK</sub> |
| Output Regulation<br>Line:<br>Load:<br>Overall Output Regulation:       | Over line, load & temp.                                  | 11.80        | ±0.02<br>±0.02 | ±0.1<br>±0.1<br>12.20 | %Vo<br>%Vo<br>V     |



ELECTRICAL SPECIFICATIONS (continued)

18–75Vin, 12V/2.5Aout

Conditions: T<sub>A</sub> = 25 °C, Airflow = 300 LFM, Vin = 48 VDC, Cin = 33 µF, unless otherwise specified.

| Absolute Maximum Ratings   |   |      |      |      |      |
|--|---|------|------|------|------|
| Parameter  | Conditions  | Min  | Typ  | Max  | Unit |
| Input Voltage  | Continuous Operation  | 0    |      | 75   | VDC  |
| Operating Temperature<br>T <sub>ref</sub> , see Thermal<br>Derating section  | Open Frame  | -40  |      | +123 | °C   |
|  | Encapsulated Module   | -40  |      | +105 | °C   |
| Storage Temperature  |   | -55  |      | +125 | °C   |
| Feature Characteristics  |   |      |      |      |      |
| Parameter  | Conditions  | Min  | Typ  | Max  | Unit |
| Switching Frequency  |   |      | 480  |      | kHz  |
| Output Voltage Trim Range  |   | -10  |      | +10  | %    |
| Output Over-voltage Protection   | Non-latching  | 115  | 130  | 140  | %    |
| Over-temperature Protection  | Avg. PCB temp,<br>non-latching  |      | 135  |      | °C   |
| Peak Backdrive Output Current<br>during startup into prebiased<br>output   | Sinking current from<br>external voltage source<br>equal to V <sub>OUT</sub> – 0.6V and<br>connected to the output<br>via 1Ω resistor.<br>C <sub>OUT</sub> =220µF, Aluminum |      | 350  | 500  | mA   |
| Backdrive Output Current in OFF<br>state   | Converter disabled  |      | 0    | 5    | mA   |
| Power On to Output Turn-ON Time  | V <sub>OUT</sub> = 0.9*V <sub>OUT_NOM</sub>   |      | 15   | 20   | mS   |
| Enable to Output Turn-ON Time  | V <sub>OUT</sub> = 0.9*V <sub>OUT_NOM</sub>   |      | 15   | 20   | mS   |
| Output Enable ON/OFF<br>Negative Enable<br>Converter ON<br>Converter OFF<br>Positive Enable<br>Converter ON<br>Converter OFF | All voltages are<br>WRT –Vin.   | -0.7 |      | 0.8  | VDC  |
|  |   | 2.4  |      | 15   | VDC  |
|  | Converter has internal<br>pull-up of approx. 5V   | 2.4  |      | 20   | VDC  |
|  |   | -0.7 |      | 1.2  | VDC  |
| Enable Pin Current Source/Sink   |   |      | 0.25 | 1    | mA   |
| Output Voltage Overshoot @<br>Startup  |   |      | 0    | 2    | %Vo  |
| Auto-Restart Period  | (OVP, OCP)  |      | 100  |      | ms   |



ELECTRICAL SPECIFICATIONS (continued)

18–75Vin, 12V/2.5Aout

Conditions: Ta = 25 °C, Airflow = 300 LFM, Vin = 48 VDC, Cin = 33 µF, unless otherwise specified.

| Efficiency   |  |      |           |     |                        |
|--|--|------|-----------|-----|------------------------|
| Parameter  | Conditions                                       | Min  | Typ       | Max | Unit                   |
| Full Load  | Vin = 24Vin                                      | 88   | 90        |     | %                      |
|  | Vin = 48Vin                                      | 87.5 | 89        |     | %                      |
| 60% Load   | Vin = 24Vin                                      | 88   | 89        |     | %                      |
|  | Vin = 48Vin                                      | 85   | 86        |     | %                      |
| Dynamic Response   |  |      |           |     |                        |
| Parameter  | Conditions                                       | Min  | Typ       | Max | Unit                   |
| Load Change 25%-50% or 50%-75% of Iout Max, di/dt = 0.1 A/µs   | Cout = 0.1 µF ceramic + 22 µF ceramic See Fig 16 |      | 80        | 120 | mV                     |
| Settling Time to 1% of Vout  |  |      | 50        |     | µS                     |
| Load Change 25%-75% or 75%-25% of Iout Max, di/dt = 0.2 A/µs   | Cout = 1 µF ceramic + 1000 µF Oscon              |      | 80        | 120 | mV                     |
| Settling Time to 1% of Vout  |  |      | 50        |     | µS                     |
| Isolation Specifications   |  |      |           |     |                        |
| Isolation Capacitance  |  |      | 1000      |     | pF                     |
| Isolation Resistance   |  | 10   |           |     | MΩ                     |
| Isolation Voltage  | Input to Output - Open Frame                     | 2250 |           |     | V <sub>DC</sub>        |
|  | Input to Output – Encapsulated                   | 1600 |           |     | V <sub>DC</sub>        |
| Reliability  |  |      |           |     |                        |
| Per Telcordia SR-332, Issue 2: Method I, Case 3 (Io=80% of Io_max, TA=40°C, airflow = 200 lfm, 90% confidence) | MTBF   |      | 3,189,953 |     | Hours                  |
|  | FITs (failures in 10 <sup>9</sup> hours)         |      | 313       |     | /10 <sup>9</sup> Hours |

Notes:

- Higher maximum external load capacitance available upon request – consult factory.

2) CHARACTERISTIC CURVES:

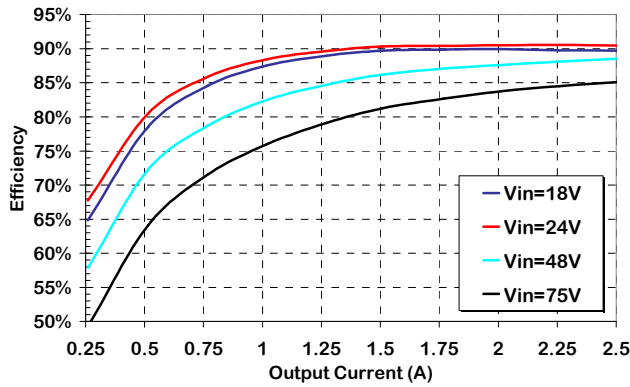

Figure 1. Efficiency vs Output Current, 300lfm airflow, 25°C ambient.

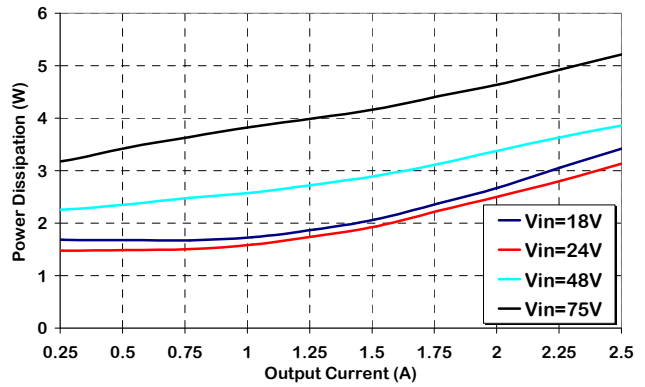

Figure 2. Power Dissipation vs. Load Current, 300lfm airflow, 25°C ambient.

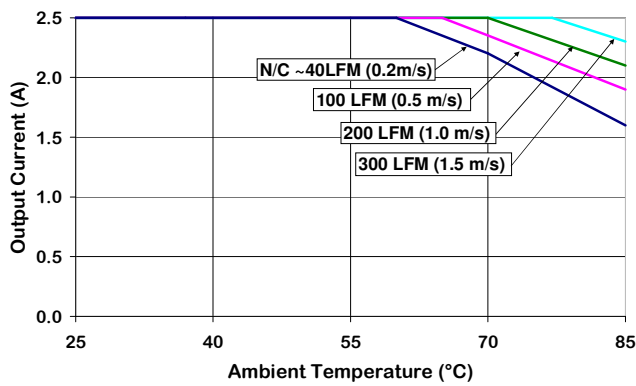

Figure 3. Output Current Derating vs Ambient Temperature & Airflow (Open Frame module) Vin = 48 V (airflow from pin 1 to pin 2)

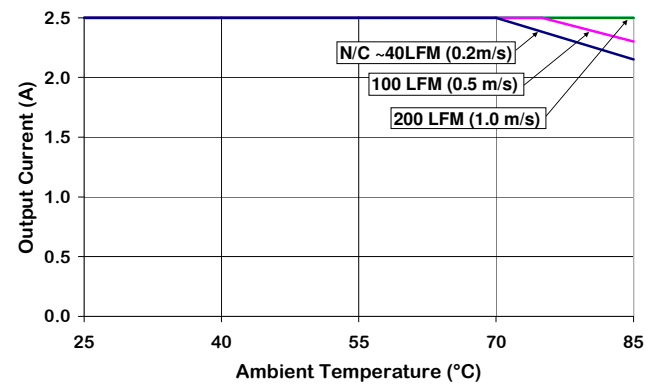

Figure 4. Output Current Derating vs Ambient Temperature & Airflow (Open Frame module) Vin = 24 V (airflow from pin 1 to pin 2)

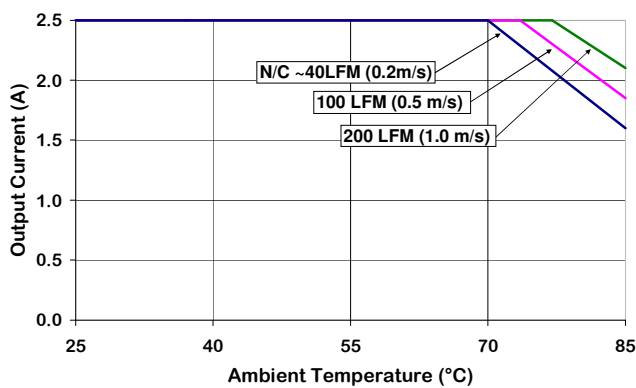

Figure 5. Output Current Derating vs Ambient Temperature & Airflow (Encapsulated module) Vin = 24V, 48V

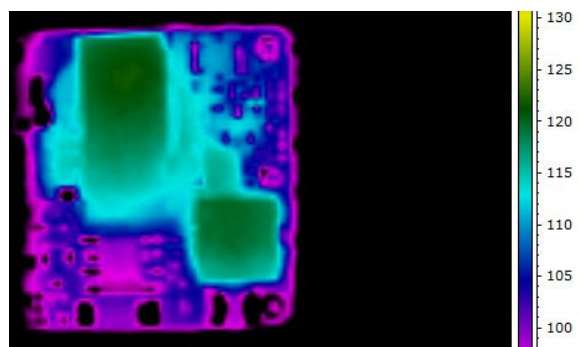

Figure 6. Thermal Image of CP30B1225036 2.5A output, 70C Ambient, 200lfm airflow, Vin = 48V, T<sub>max</sub> = 122°C

CHARACTERISTIC WAVEFORMS:

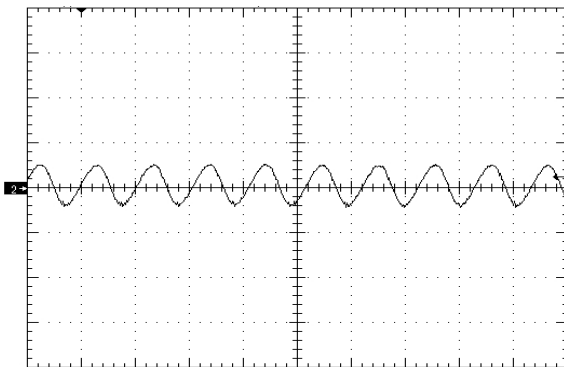

Figure 7. Input Reflected Ripple Current (20mA/div), time scale – 2uS/div. Vin=Vin\_nom, full load (see Fig 15)

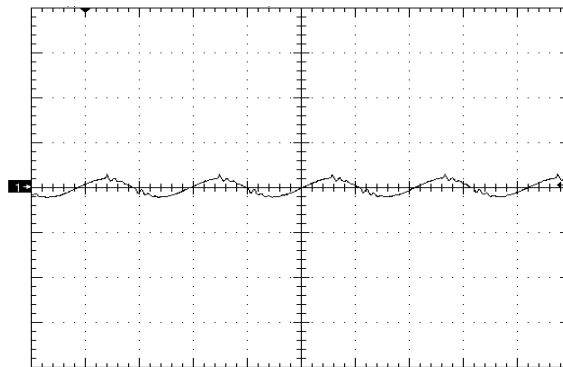

Figure 8. . Output Voltage Ripple (20mV/div), time scale – 1uS/div. Vin=Vin\_nom, full load Cout=0.1uF ceramic + 22uF ceramic (see Fig 16)

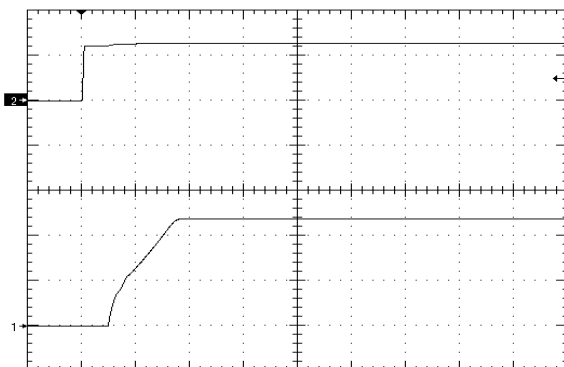

Figure 9. Startup Waveform via Enable Pin, time scale 4mS/div. Vin=Vin\_nom, Iout=no load Cout=0, Ch1=Vout (5V/div), Ch2=Enable (5V/div)

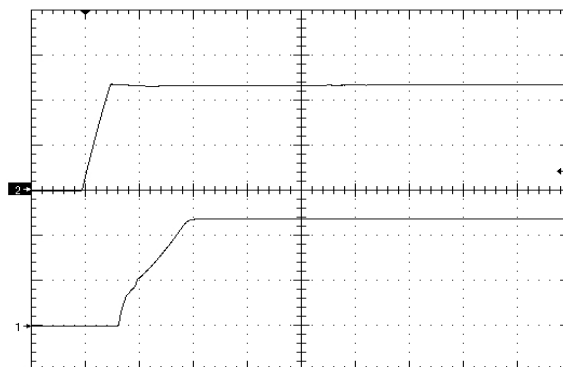

Figure 10. Startup Waveform via Line Voltage, time scale 4mS/div. Vin=Vin\_nom, Iout=full load Cout=0uF, Ch1=Vout (5V/div), Ch2=Vin (20V/div)

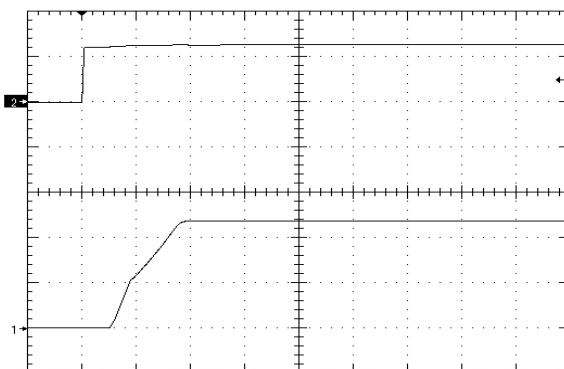

Figure 11. Startup Waveform via Enable Pin, time scale 4mS/div. Vin=Vin\_nom, Iout=full load Cout=2200uF, Ch1=Vout (5V/div), Ch2=Enable (5V/div)

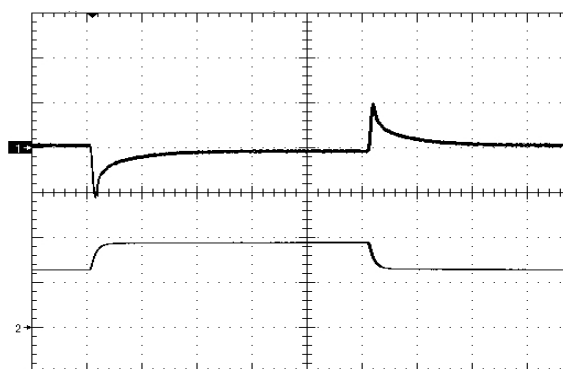

Figure 12. Load Transient Response (100mV/div), di/dt=0.1A/uS, 50%-75%-50% of full load, Cout=Fig16 time scale: 200uS/div. Ch1=Vout, Ch2=Iout (1A/div)

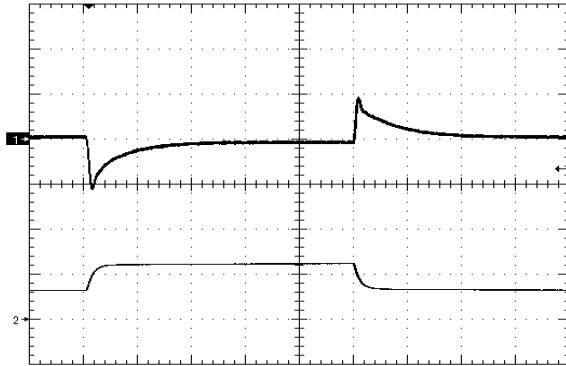

Figure 13. Load Transient Response (100mV/div), di/dt=0.1A/uS, 25%-50%-25% of full load, Cout=Fig16 time scale: 200uS/div. Ch1=Vout, Ch2=Iout (1A/div)

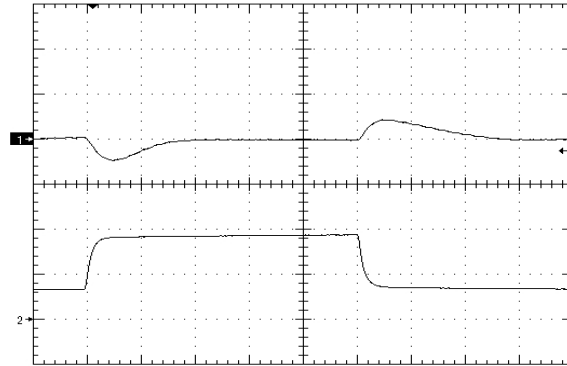

Figure 14. Load Transient Response 100mV/div), di/dt=0.2A/uS, 25% - 75% - 25% of full load +1000uF low ESR Oscon, time scale: 200uS/div. Ch1=Vout, Ch2=Iout (1A/div)





## Application Notes

### INPUT REFLECTED RIPPLE TEST SETUP:

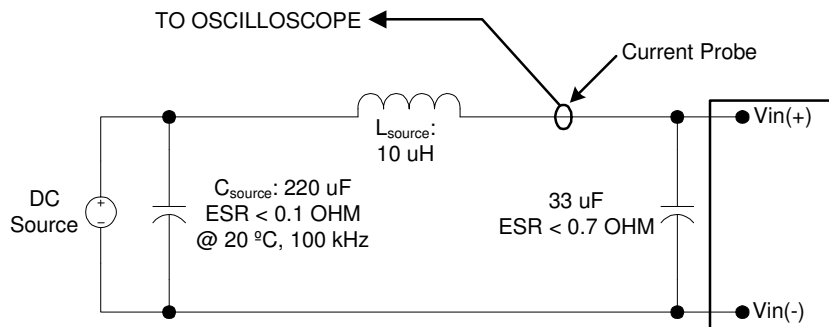

Note: Measure input reflected-ripple current with a simulated source inductance ( $L_{test}$ ) of 10  $\mu$ H. Capacitor  $C_s$  offsets possible source impedance.

Figure 15. Input Reflected-ripple Current Test Setup.

### OUTPUT RIPPLE TEST SETUP:

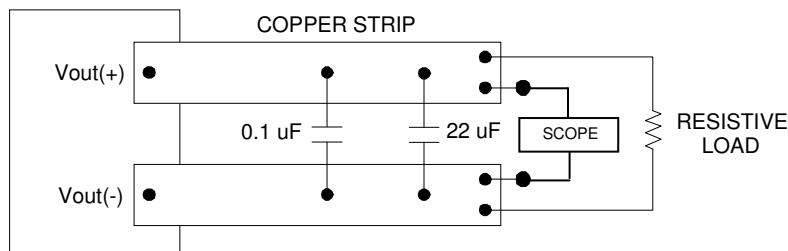

Use a 0.1  $\mu$ F X7R ceramic capacitor and 22  $\mu$ F @16V X7R ceramic capacitor. Scope measurement made using a BNC socket. Position the load 3 in. [76mm] from module.

Figure 16. Peak-to-Peak Output Noise Measurement Test Setup.

## Application Notes (cont)

### OUTPUT VOLTAGE TRIM:

Output voltage adjustment is accomplished by connecting an external resistor between the Trim Pin and either the +Vout or -Vout Pins.

- TRIM UP EQUATION:

$$R_{\text{TRIM\_UP}}(\Omega) = \frac{25000}{V_{\text{DES}} - 12} - 5100$$

Where  $R_{\text{TRIM\_UP}}$  is the resistance value in ohms and  $V_{\text{DES}}$  is the desired output voltage.

E.g. to trim the output up 10%,  $R_{\text{TRIM\_UP}} = \frac{25000}{13.2 - 12} - 5100 \cdot \Omega$  or  $R_{\text{TRIM\_UP}} = 15.73 \text{ k}\Omega$

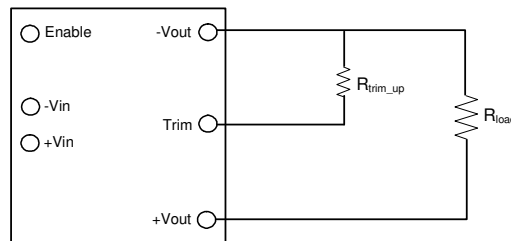

Figure 17. Trim UP circuit configuration

- TRIM-DOWN EQUATION:

$$R_{\text{TRIM\_DOWN}}(\Omega) = \frac{10000 \cdot (V_{\text{DES}} - 2.5)}{12 - V_{\text{DES}}} - 5100$$

Where  $R_{\text{TRIM\_DOWN}}$  is the resistance value in ohms and  $V_{\text{DES}}$  is the desired output voltage.

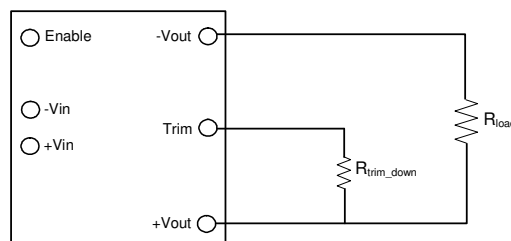

Figure 18. Trim DOWN circuit configuration



## Application Notes (cont)

### Thermal Derating

- It is preferable that the DC-DC module have an unobstructed flow of air across it for best thermal performance. Components taller than ~ 2mm in front of the module can deflect airflow and possibly create hotspots.
- Significant cooling is achieved through conductive flow from the modules I/O pins to the host PCB. Sufficiently large traces connecting the dc-dc converter to the source and load will help ensure thermal derating performance will meet or exceed the derating curves published in this datasheet.
- If the module is expected to be operated near the load limits defined in the derating curves, in-system verification of module derating performance should be performed to ensure long-term system reliability. Peak temperatures are to be measured using infrared thermography or by gluing a fine gauge (AWG #40) thermocouple at the  $T_{ref}$  location(s) shown below. Temperature at the specified location(s) should be kept below 123°C for open frame units, 105°C for encapsulated modules in order to maintain optimum converter reliability.

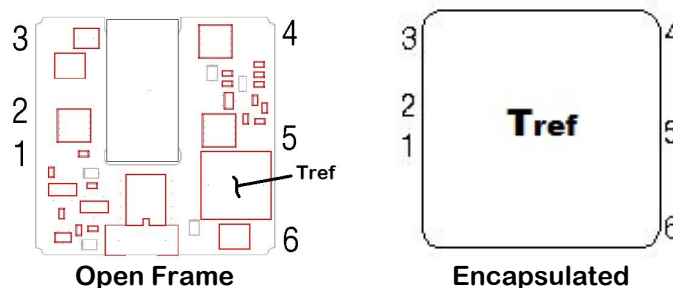

### Input Undervoltage Lockout

- The converter is disabled until the input voltage has exceeded the UVLO turn-on threshold. Once the input voltage exceeds this level (see Input Under-Voltage Lock-out in Electrical Specifications table) the module will commence soft-start. Hysteresis of 1-3 volts minimizes the likelihood of pulling the input voltage below the turn-off threshold during startup which could create an undesirable on/off cycling condition. The converter will continue to operate until the input voltage subsequently falls below the UVLO turn-off threshold.

### Enable Pin Function

- The module has a remote enable function that allows it to be turned on or off remotely. The Enable pin is referenced to the negative input pin (-Vin) of the converter. Modules can be ordered with either negative or positive enable.
- The negative enable option the module will not turn on unless the enable pin is connected to -Vin. The positive enable option allows the converter to turn on as soon as voltage sufficient to exceed the UVLO of the converter has been applied to the input terminals. In this case the module is turned off by connecting the Enable pin to -Vin. On/off thresholds are located in the Electrical Specifications table.

## Application Notes (cont)

### Output Overvoltage Protection

- The module has an independent feedback loop that will disable the output of the converter if a voltage greater than about 125% of the nominal set point is detected. When this threshold is reached, the converter will shut down and remain off for the amount of time specified by the Auto-Restart Period. The converter will attempt a restart once this period of time has elapsed.

### Output Overtemperature Protection

- To provide protection under certain fault conditions, the unit is equipped with a thermal shutdown circuit. The unit will shutdown if the average PCB temperature exceeds approx. 135°C, but the thermal shutdown is not intended as a guarantee that the unit will survive temperatures beyond its rating. The module will automatically restart once it has cooled below the shutdown temperature minus hysteresis (typically 20 deg C.)

### SMT Version Layout Considerations (if applicable)

- Copper traces with sufficient cross-section must be provided for all output & input pins. SMT pads tied to internal power/ground planes must have multiple vias around each SMT pad to couple expected current loads from module pins into internal traces/planes. One 0.024" (0.6mm) diameter via for each 4A of expected source or load current must be provided as close to the termination as possible, preferably in the direction of current flow from SMT pad to load. Vias must be at least 0.024" (0.6 mm) away from the SMT pad to prevent solder from flowing into the vias.
- SMT pads on the host card are to be 0.075" (1.9mm) diameter. Solder paste screen opening should be 0.70" diameter and the screen should be 0.006" (0.15 mm) thick (other thicknesses are possible; 0.006" provides a good compromise between solder volume and coplanarity compensation.)

### Paralleling Converters

- Modules may be paralleled but it is recommended that the total power draw not exceed the output power rating of a single module. External sharing controllers are recommended for reliability and to ensure equal distribution of the load to the converters.



Application Notes (cont)

EMC Compliance

To meet Class B compliance for EN55032 (CISPR 32) or FCC part 15 sub part j, the following input filter is required:

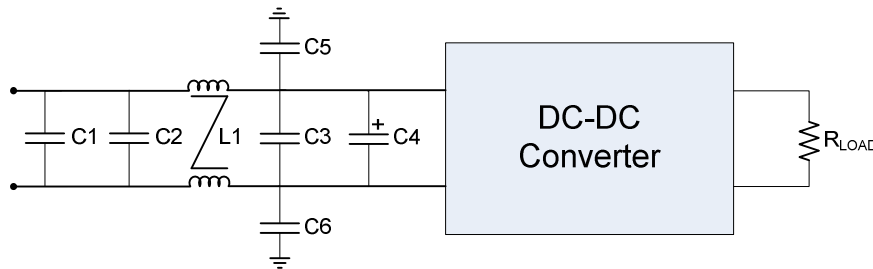

Figure 19. EMI Filter

|            |  |
|------------|--|
| L1 =       | 1.32 mH Common Mode Inductor (Pulse P0420NL) |
| C1,C2,C3 = | 2.2uF ceramic                                |
| C4 =       | 100uF electrolytic                           |
| C5,C6 =    | 10nF (@2kV if output is ref. to gnd.)        |

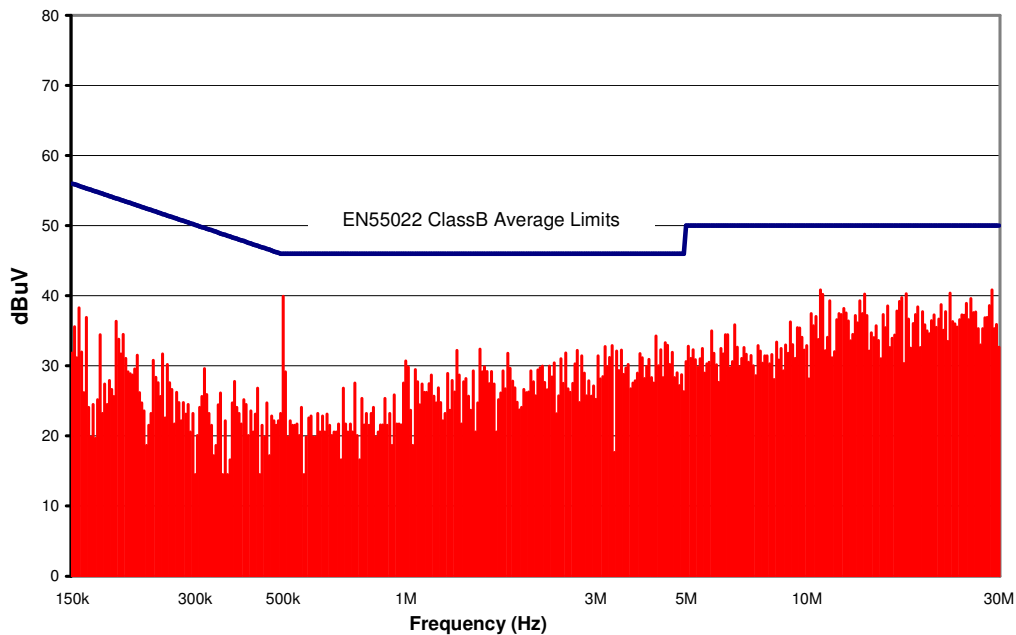

Figure 20. CP30\_1225036 Conducted Emissions using above specified input filter. Vin = 48V, Full Resistive Load

**MODULE PIN ASSIGNMENT:**

| PIN # | DESIGNATION          | NOTES  |
|-------|----------------------|--|
| 1     | V <sub>IN</sub> (+)  | 1) All dimensions in inches [mm]<br>Tolerances: .xx ± 0.02 [.x ± .5]<br>.xxx ± 0.010 [.xx ± .25]<br>2) TH pins Ø 0.040" [1.02] with Ø 0.070" [1.77] standoff shoulders.<br>3) SMT pins are Ø 0.070" lead-free<br>4) Keep Out Area – no copper traces or vias should be placed in this area.<br>5) All pins are gold plated with nickel under plating (ROHS).<br>6) Weight: 7.54 g (0.266 oz.) open frame, 19g (0.67 oz.) encapsulated<br>7) Workmanship: Meets or exceeds IPC-A-610 Class II |
| 2     | V <sub>IN</sub> (-)  |  |
| 3     | On/Off               |  |
| 4     | V <sub>OUT</sub> (-) |  |
| 5     | Trim                 |  |
| 6     | V <sub>OUT</sub> (+) |  |
| 6     | V <sub>OUT</sub> (+) |  |

**MECHANICAL OUTLINE - Open Frame:**

**Through-hole**

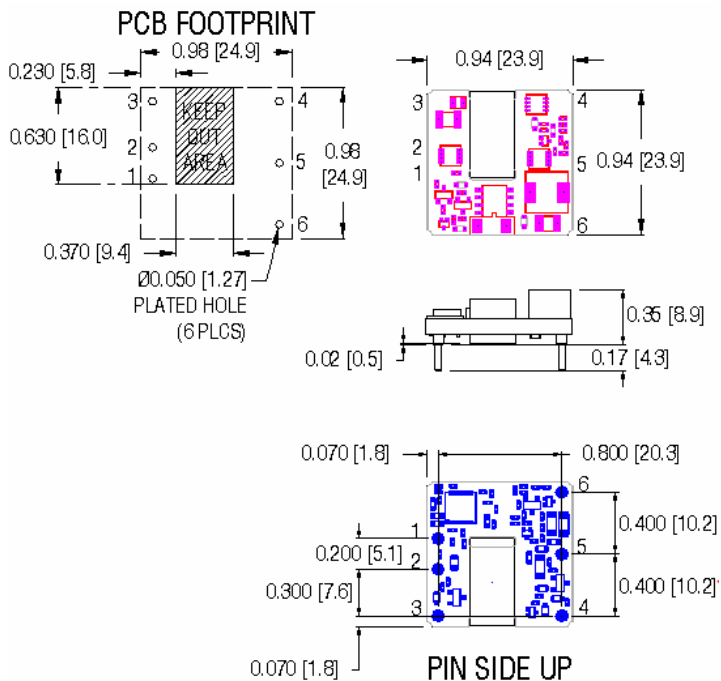

**Surface Mount**

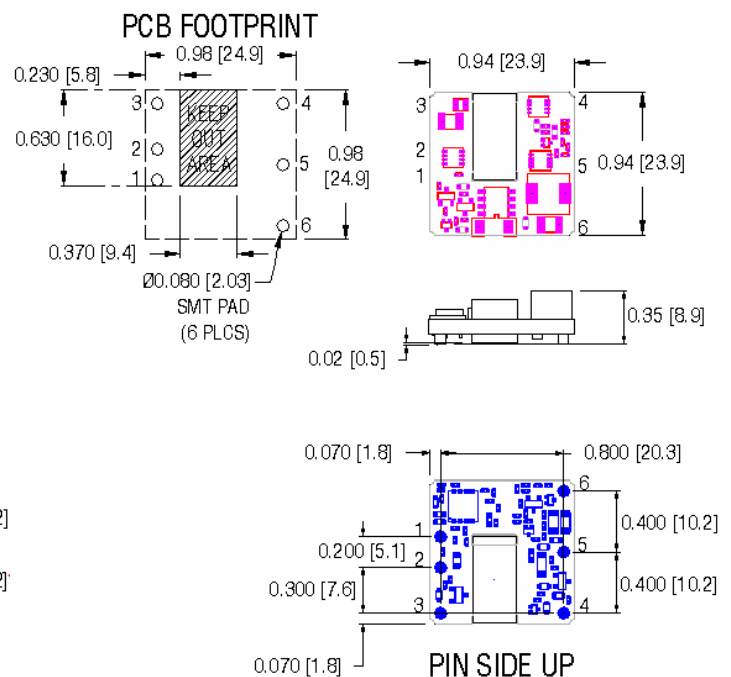

**Note: keep out area should be free of copper traces**

MECHANICAL OUTLINE – Encapsulated Module:

PCB FOOTPRINT

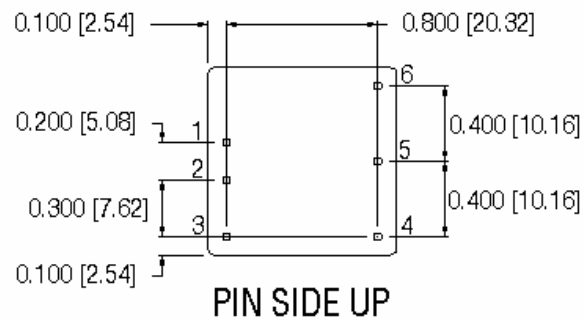
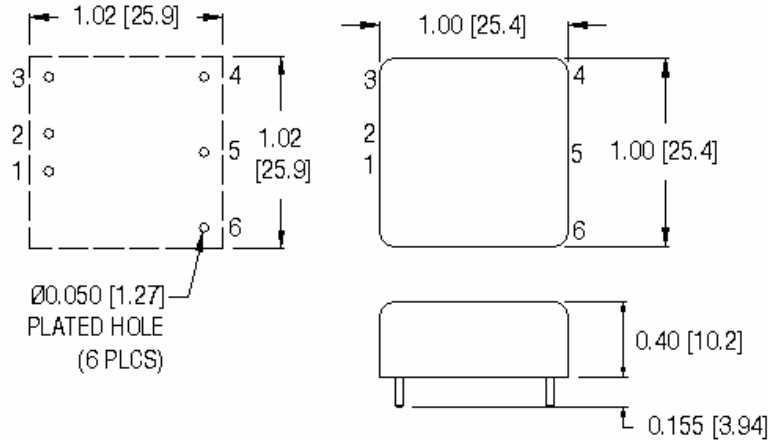

**Ordering Information:**

| Product Series | Package Configuration              | No. of Outputs | Output Voltage | Output Current | Input Voltage | Enable logic option   | SMT Option    |
|----------------|------------------------------------|----------------|----------------|----------------|---------------|---|---------------|
| CP30           | B or C                             | 1              | 2              | 250            | 36            | N or P  | S             |
| 30W 1x1        | B = Open Frame<br>C = Encapsulated | 1 output       | 12V            | 2.5A           | 18 – 75V      | N = Negative<br>P = Positive<br>Blank = No Enable or Trim Pin | Surface Mount |

Rev 1.1, 14-Feb-18

